



LED Technical Data



LED Premier Series

TCP's LED Premier Series recessed troffers gives you full body, full panel diffusion, with the appearance of a soft warm glow.

LIMITLESS OPTIONS for the following applications:

Offices	Schools
Restaurants	Hospitals
Retail Stores	Grid Ceilings
Lobbies	



Great Features/Benefits

- Energy efficient – Up to 42% energy savings compared to fluorescent alternatives
- Long life: 50,000 hours
- Smooth, uniform dimming
- High efficiency alternative to T5, T8 and T12 linear fluorescent troffers
- Excellent color consistency and superior lumen maintenance



5 YEAR WARRANTY

LED Premier Series Recessed Troffers

Features/Benefits

Up to 42% less energy than fluorescent alternatives.	Instant energy savings.
Long 50,000 hour rated life.	Minimizes replacements & maintenance costs.
Very low heat generation.	Less energy wasted as heat.
Excellent color consistency & CRI.	Enhances color of focal point while maintaining uniformity throughout lighting installation.
Mercury free	Great for all environments.
Fits standard 1" and 9/16" T-bar grids.	Easy installation and retrofit application.
TCP LED drivers are specifically designed for high efficient LED combination.	Optimal performance and efficiency.



2 x 2 LED
Premier Series Recessed Troffer



2 x 4 LED
Premier Series Recessed Troffer

Specifications

Input Line Voltage	120-277 VAC
Input Power	2x2: 35-45W 2x4: 45-89W
Input Line Frequency	50/60HZ
Luminaire Life (Rated)	50,000 hours
Minimum Starting Temperature	-30°C
Maximum Operating Temperature	40°C
CRI	82
Power Factor	>90%
THD	<20%

Warranty

Five year limited warranty against defects in manufacturing.



5 YEAR WARRANTY

Replacement Comparison

SYSTEM	BALLAST FACTOR	LUMENS	INPUT WATTS	ENERGY SAVINGS
TCP 3200 Lumen 2X2 LED		3200	35	-
2 Lamp 31W U-Bend	0.88	3790	59	41%
2 Lamp 24W T5 HO	1.0	3145	54	35%
TCP 4000 Lumen 2X2 LED		4200	45	-
2 Lamp 34W T12 U-Bend	0.88	4420	74	39%
2 Lamp 32W T8 U-Bend	0.88	4275	58	22%
2 Lamp 24W T5 HO	1.0	3145	54	17%

SYSTEM	BALLAST FACTOR	LUMENS	INPUT WATTS	ENERGY SAVINGS
TCP 4000 Lumen 2X4 LED		4200	45	-
2 Lamp 32W T8 HBF	1.18	4658	65	31%
2 Lamp 28W T5	1.0	4675	63	29%
2 Lamp 32W T8 NBF	0.88	4468	59	24%
TCP 6800 Lumen 2X4 LED		6800	70	-
3 Lamp 32W T8 HBF	1.18	6960	93	25%
3 Lamp 32W T8 NBF	0.88	6681	89	21%
TCP 8000 Lumen 2X4 LED		8000	89	-
4 Lamp 32W T8 HBF	1.18	8965	153	42%
2 Lamp 54W T5	1.0	8000	117	24%
4 Lamp 32W T8 NBF	0.88	8606	112	21%

2x2 LED Premier Series Recessed Troffers

Applications

The TCP LED Premier Series Recessed Troffers are high efficiency alternatives to T5, T8 and T12 linear fluorescent troffers. Our intelligent high performance LED light engines and drivers deliver long life, consistent color, and superior lumen maintenance. Applications include offices, schools, retail locations, hospitals, and other grid ceilings.

Construction

The TCP LED troffer is constructed of rugged cold-rolled steel, post painted with a highly diffuse white finish, and an impact resistant acrylic diffuser. The housing is designed to mount in a variety of grid ceiling types.

Electrical

All electrical components are UL/cUL listed. TCP high efficiency drivers provide consistent power to ensure even lighting from the long life LEDs. Each driver is matched to a light engine to deliver 50,000 hours life. Full range dimming is optional.

Optics

The impact resistant acrylic diffuser provides a wide distribution of light and comes in two styles, frosted white or A12 clear prismatic. The frosted white diffuser provides an even glow while the clear prismatic diffuser mimics the look of traditional prismatic troffers.



Listings

- UL/cUL Listed – damp location rated
- Design Lights Consortium (DLC) Qualified Products List
- RoHS Compliant
- Chicago Plenum Compliant (when option selected)

Warranty

Five year limited warranty against defects in manufacturing.

Lumen Maintenance

Lumen Maintenance Factor (LMF)			
36,000 hours ¹	50,000 hours ²	100,000 hours ²	L ₇₀ (hours) ²
92.06%	89.57%	81.31%	177,000

¹ IESNA TM-21-11 projected value based on 6X IESNA LM-80-08 total test duration of 6,000 hours.
² IESNA TM-21-11 calculated value exceeds 6X IESNA LM-80-08 total test duration of 6,000 hours.

Catalog Ordering Matrix Example: TCPTRF2UNI4030K

TCP		2					
BRAND	FAMILY	SIZE	VOLTAGE	CONTROLS/DIMMING	LUMEN PACKAGE (Power) ¹²	COLOR TEMPERATURE	OPTIONS
TCP – TCP Premier	TRF – Frosted White TRP – Prismatic	2 – 2' x 2'	UNI – 120V-277V 120 – 120V*	(blank) – Non Dimming DIM – Line Dimming*	32 – 3200 Lumens (35W) 40 – 4200 Lumens (45W)	30K – 3000K 35K – 3500K 41K – 4100K 50K – 5000K	CP07 – Emergency Backup CP – Chicago Plenum

¹ Approximate lumen output. Actual performance may vary based on CCT, options selected and end user application.
² Actual wattage may differ by +/- 5%; when operating between 120-277V +/- 10%.

For the most up-to-date specs and warranty information, please visit www.tcp.com

2x2 LED Premier Series Recessed Troffers

Dimensions and Mounting Data

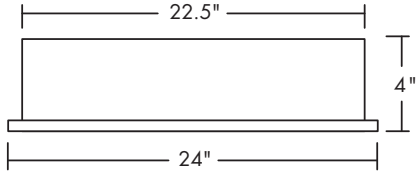

Length: 24" All dimensions are in inches
 Width: 24" unless otherwise specified.
 Depth: 4"

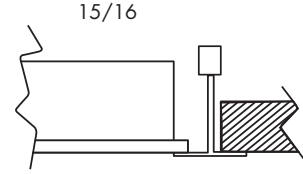
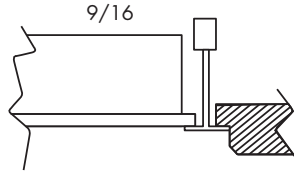

Photometric Report

Luminous Intensity Distribution Diagram

TCPTRF2UNI4030K

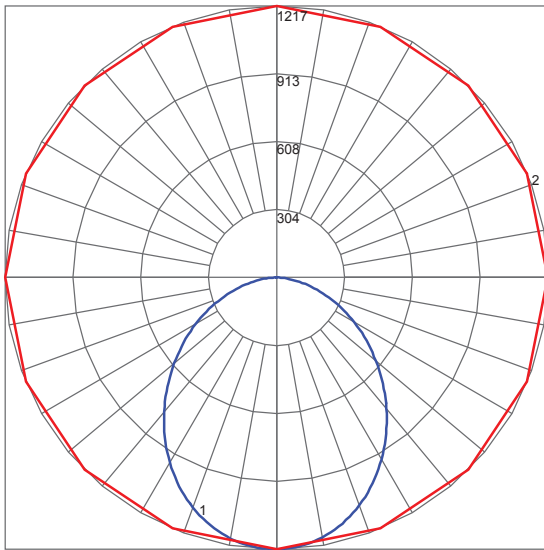

Maximum Candela = 1216.87 Located At Horizontal Angle = 225, Vertical Angle = 1
 # 1 - Vertical Plane Through Horizontal Angles (225 - 45) (Through Max. Cd.)
 # 2 - Horizontal Cone Through Vertical Angle (1) (Through Max. Cd.)

Coefficients of Utilization

Effective Floor Cavity Reflectance 0.20

RC RW	80				70				50			30			10			0
	70	50	30	10	70	50	30	10	50	30	10	50	30	10	50	30	10	0
0	119	119	119	119	116	116	116	116	111	111	111	106	106	106	102	102	102	100
1	109	105	101	97	106	102	99	95	98	95	92	94	92	89	91	89	87	85
2	100	92	85	80	97	90	84	79	86	81	77	83	79	75	80	77	73	71
3	91	81	73	67	89	79	72	66	76	70	65	74	68	64	71	67	63	61
4	84	72	64	57	82	71	63	57	68	61	56	66	60	55	64	59	54	52
5	77	65	56	50	75	64	55	49	61	54	49	60	53	48	58	52	48	46
6	71	58	50	44	70	58	49	43	56	48	43	54	48	43	52	47	42	40
7	66	53	45	39	65	52	44	38	51	44	38	49	43	38	48	42	38	36
8	62	49	40	35	60	48	40	35	47	39	34	45	39	34	44	38	34	32
9	58	45	37	31	57	44	36	31	43	36	31	42	36	31	41	35	31	29
10	54	41	34	28	53	41	33	28	40	33	28	39	33	28	38	32	28	26

Zonal Lumen Summary

Zone	Lumens	%Lamp	%Fixt
0-30	908.74	N.A.	30.60
0-40	1449.22	N.A.	48.70
0-60	2424.9	N.A.	81.50
0-90	2971.66	N.A.	99.90
90-120	0.50	N.A.	0.00
90-130	1.04	N.A.	0.00
90-150	2.25	N.A.	0.10
90-180	2.93	N.A.	0.10
0-180	2974.59	N.A.	100.00

Total Luminaire Efficiency = 100.00%

Specifications and dimensions subject to change without notice.

2x4 LED Premier Series Recessed Troffers

Applications

The TCP LED Premier Series Recessed Troffers are high efficiency alternatives to T5, T8 and T12 linear fluorescent troffers. Our intelligent high performance LED light engines and drivers deliver long life, consistent color, and superior lumen maintenance. Applications include offices, schools, retail locations, hospitals, and other grid ceilings.

Construction

The TCP LED troffer is constructed of rugged cold-rolled steel, post painted with a highly diffuse white finish, and an impact resistant acrylic diffuser. The housing is designed to mount in a variety of grid ceiling types.

Electrical

All electrical components are UL/cUL listed. TCP high efficiency drivers provide consistent power to ensure even lighting from the long life LEDs. Each driver is matched to a light engine to deliver 50,000 hours life. Full range dimming is optional.

Optics

The impact resistant acrylic diffuser provides a wide distribution of light and comes in two styles, frosted white or A12 clear prismatic. The frosted white diffuser provides an even glow while the clear prismatic diffuser mimics the look of traditional prismatic troffers.

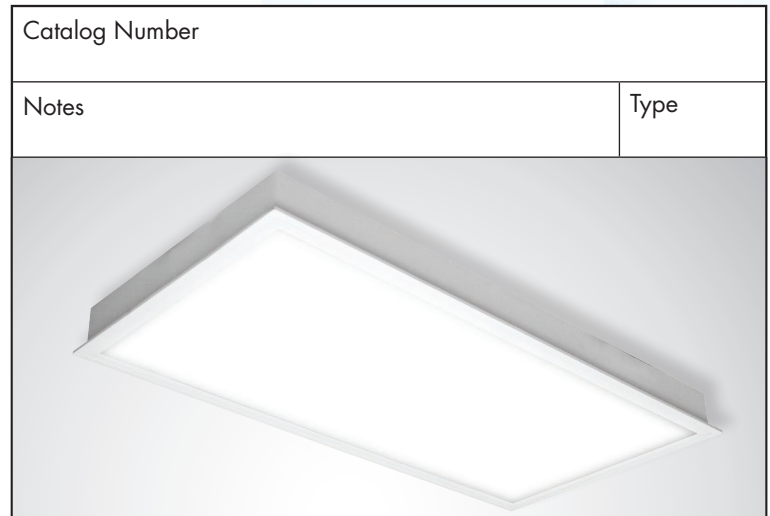

Listings
 UL/cUL Listed – damp location rated
 Design Lights Consortium (DLC) Qualified Products List
 RoHS Compliant
 Chicago Plenum Compliant (when option selected)

Warranty
 Five year limited warranty against defects in manufacturing.

Lumen Maintenance

Lumen Maintenance Factor (LMF)			
36,000 hours ¹	50,000 hours ²	100,000 hours ²	L ₇₀ (hours) ²
92.06%	89.57%	81.31%	177,000

¹ IESNA TM-21-11 projected value based on 6X IESNA LM-80-08 total test duration of 6,000 hours.
² IESNA TM-21-11 calculated value exceeds 6X IESNA LM-80-08 total test duration of 6,000 hours.

Catalog Ordering Matrix Example: TCPTRF4UNI6830K							
BRAND	FAMILY	SIZE	VOLTAGE	CONTROLS/DIMMING	LUMEN PACKAGE (Power) ^{1,2}	COLOR TEMPERATURE	OPTIONS
TCP – TCP Premier	TRF – Frosted White TRP – Prismatic	4 – 2' x 4'	UNI – 120V-277V 120 – 120V*	(blank) – Non Dimming DIM – Line Dimming*	40 – 4200 Lumens (45W) 68 – 6800 Lumens (70W) 80 – 8000 Lumens (89W)	30K – 3000K 35K – 3500K 41K – 4100K 50K – 5000K	CP07 – Emergency Backup CP – Chicago Plenum

¹ Approximate lumen output. Actual performance may vary based on CCT, options selected and end user application.
² Actual wattage may differ by +/- 5%; when operating between 120-277V +/- 10%.

For the most up-to-date specs and warranty information, please visit www.tcpi.com

2x4 LED Premier Series Recessed Troffers

Dimensions and Mounting Data

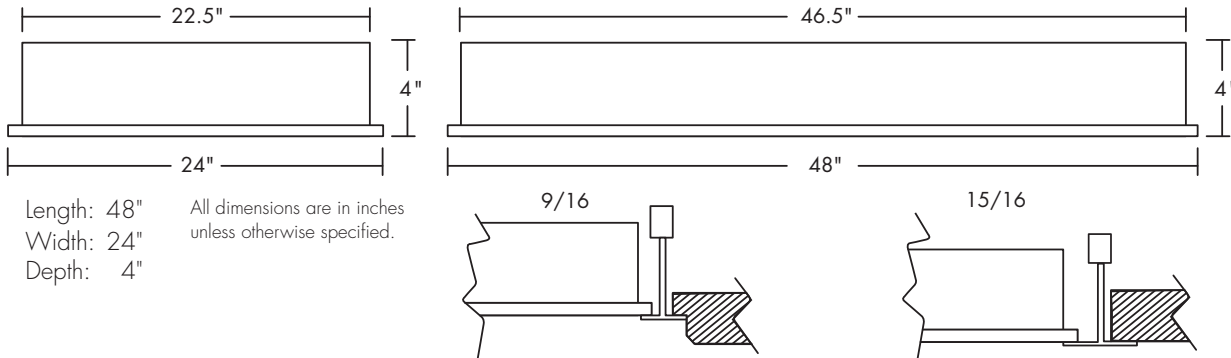

Photometric Report

Luminous Intensity Distribution Diagram

TCPTRF4UNI6830K

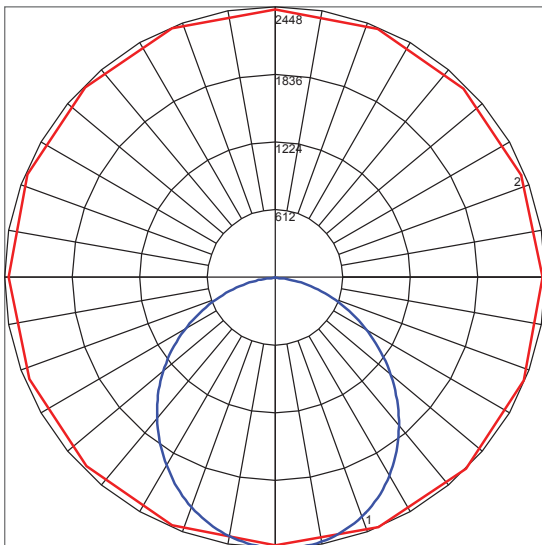

Maximum Candela = 2447.76 Located At Horizontal Angle = 315, Vertical Angle = 3
1 - Vertical Plane Through Horizontal Angles (315 - 135) (Through Max. Cd.)
2 - Horizontal Cone Through Vertical Angle (3) (Through Max. Cd.)

Coefficients of Utilization

Effective Floor Cavity Reflectance 0.20

RC	80				70				50			30			10			0
	70	50	30	10	70	50	30	10	50	30	10	50	30	10	50	30	10	0
0	119	119	119	119	116	116	116	116	111	111	111	106	106	106	102	102	102	100
1	109	104	100	96	106	102	98	95	98	95	92	94	91	89	90	88	86	84
2	99	91	85	79	97	89	83	78	86	81	76	83	78	74	79	76	73	71
3	91	80	72	66	88	79	71	65	76	69	64	73	68	63	70	66	62	60
4	83	71	63	56	81	70	62	56	68	60	55	65	59	54	63	58	53	51
5	77	64	55	48	74	63	54	48	61	53	48	59	52	47	57	51	47	45
6	71	58	49	42	69	57	48	42	55	47	42	53	47	41	52	46	41	39
7	66	52	44	38	64	52	43	37	50	43	37	49	42	37	47	41	37	35
8	61	48	39	34	60	47	39	33	46	38	33	45	38	33	43	37	33	31
9	57	44	36	30	56	43	36	30	42	35	30	41	35	30	40	34	30	28
10	54	41	33	28	52	40	33	27	39	32	27	38	32	27	37	31	27	25

Zonal Lumen Summary

Zone	Lumens	%Lamp	%Fixt
0-30	1860.77	N.A.	29.00
0-40	3011.33	N.A.	47.00
0-60	5160.31	N.A.	80.50
0-90	6401.38	N.A.	99.90
90-120	3.71	N.A.	0.10
90-130	4.87	N.A.	0.10
90-150	6.49	N.A.	0.10
90-180	7.30	N.A.	0.10
0-180	6408.68	N.A.	100.00

Total Luminaire Efficiency = N.A.%

Specifications and dimensions subject to change without notice.