

PROJECT: _____

SCHEDULE: _____ DATE: _____

PREPARE BY: _____

NOTES: _____

T8 TUBE TYPE A+B

DESCRIPTION

The naturalLED® T8 Type A+B tube offers a versatile retrofit solution for existing 4' fluorescent fixtures, providing two installation options. It functions as a plug-and-play replacement with Type A compatibility, allowing direct use with an electronic ballast, or can operate as a Type B lamp by bypassing the ballast for direct line voltage operation. Designed to replace 32-watt fluorescent tubes, it features a frosted lens that ensures evenly diffused, efficient lighting, making it ideal for offices, schools, retail spaces, and other commercial applications. With a universal design, it supports both shunted and non-shunted sockets, offering flexibility for various fixture types.



APPLICATIONS

Retails, Restaurants, Hospitalities, Offices, Schools





Rated Life Hours 50,000
Warranty 5 Years

FEATURES

- DLC Standard
- UL/cUL Listed
- IP20/Damp Location
- Color Selectable
- Wattage: 8W, 12W, 15W, 17W
- Color Temp: CCT3 (35/40/50K), CCT5 (30/35/40/50/65K)
- Voltage: 120-277V
- Surge Protection: 1KV
- Dimmable: Yes
 - CCT3: With Dimming Module
 - CCT5: With Dimming Module/Phase-Cut Triac Dimmers
- CRI: >80
- Operating Temperature: -4°F to 113°F
- Beam Angle: 325°
- Instant On
- Base: G13 Socket (Single + Double Ended)
- Shatter-proof Type: PET Coated
- Length: 2-ft, 3-ft, 4-ft
- Color: Bronze
- Optional Accessories for Purchase: Emergency Driver, Dimming Module
- Warranty: 5-Year Limited Warranty

ACCESSORIES

	Emergency Driver
	Dimming Module

SAMPLE NUMBER		LED8T8/24FR10/8CCT5/AB/UNV		
WATTAGE	SERIES	LENGTH	CRI/COLOR TEMP	TYPE
LED8 8-Watt	T8 T8 Tube	24FR 24-inch Frosted	8CCT5 5CCT (30/35/40/50/65K) 3CCT (35/40/50K)	AB/UNV Type A + B Universal



TUBE T8 TYPE A + B

TUBE LUMINAIRES

*P= Premium DLC / *S = Standard DLC

ORDERING

Ordering Code	Description	Watts (W)	Lumens (Lm)	CCT (K)	Equiv. Wattage (W)	Voltage	Length	Rating	DLC (S/P)
4658	LED8T8/24FR10/8CCT5/AB/UNV	8	1,000	5CCT (30/35/40/50/65K)	17W	120-277V	2-ft	IP20	S
4659	LED12T8/36FR15/8CCT5/AB/UNV	12	1,500	5CCT (30/35/40/50/65K)	25W	120-277V	3-ft	IP20	S
4660	LED15T8/FR20/8CCT5/AB/UNV	15	2,000	5CCT (30/35/40/50/65K)	32W	120-277V	4-ft	IP20	S
4616	LED15T8/FR20/8CCT3/AB/UNV	17	2,050	3CCT (35/40/50K)	32W	120-277V	4-ft	Damp	S

ACCESSORIES



Emergency Driver

7337 BAEM25-170BC/347-C

(25W Emergency Driver 170Vdc Micro Invertor)



Dimming Module

P10568 BALED-100W-T8AB-DIM

(Dimming Module)

PACKAGE

	Master Carton (pc)	Dimensions (in)	Weight (lb)
2-ft	25	26.40"x6.50"x6.50"	10.14
3-ft	25	38.20"x6.50"x6.50"	13.67
4-ft (15W)	25	50"x6.50"x6.50"	18.08
4-ft(17W)	25	50"x6.50"x6.50"	15.21

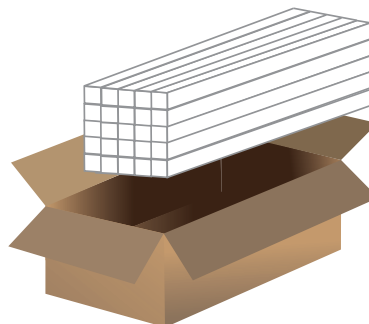

DIMENSIONS

8 Watt [2-ft]
0.287-lbs (130g)

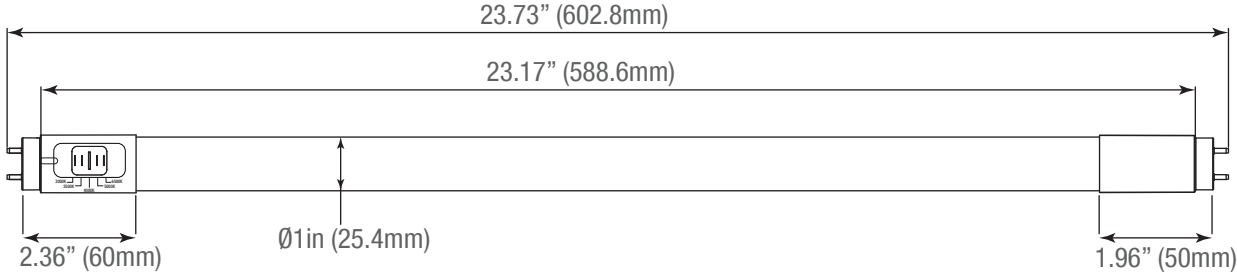

12 Watt [3-ft]
0.375-lbs (170g)

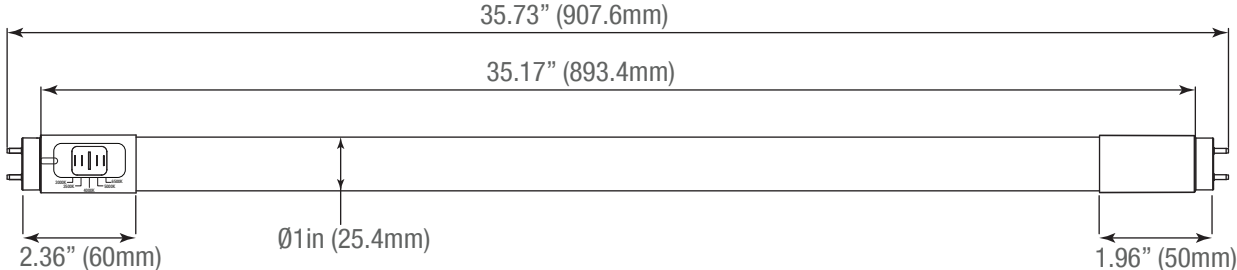

15 Watt [4-ft]
0.5-lbs (230g)

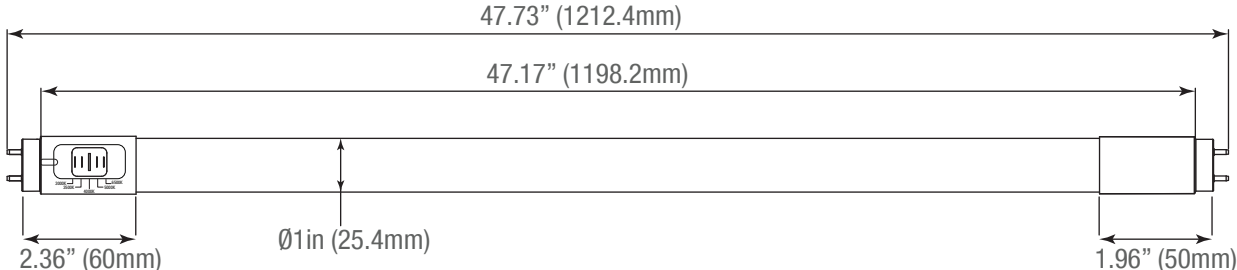

17 Watt
0.547-lbs (248g)

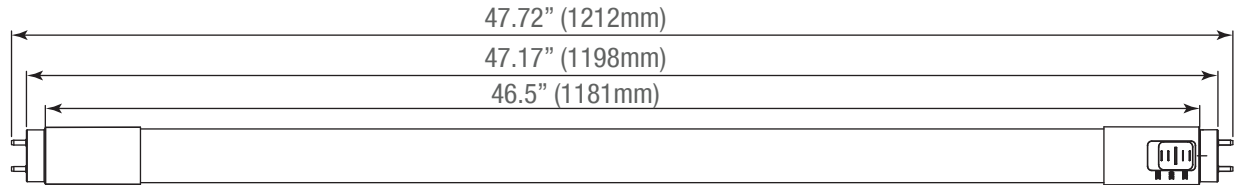

1" (25.4mm)

PHOTOMETRICS

15 Watt [4-ft]

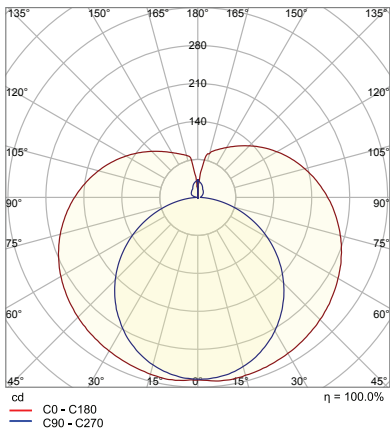

BUG rating B1 U3 G1

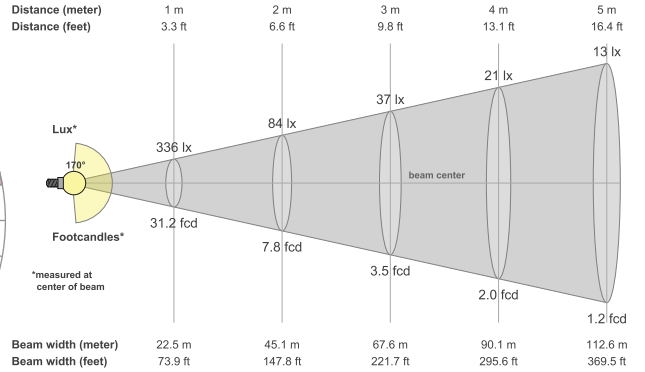
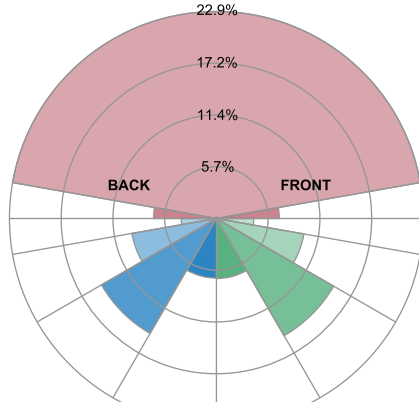

17 Watt [4-ft]

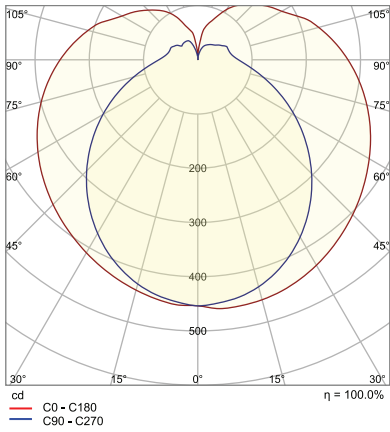

BUG rating B1 U3 G1

