



KT-WPLED60-M2-8XX-VDIM

ARCHITECTURAL 60W FULL-CUTOFF LED WALL PACK

DESCRIPTION

Architectural 60W Full-Cutoff LED Wall Pack | 120–277V Input | 4000–5000K | Medium-Size Bronze Housing | Wide Optic Lens

APPLICATION

Building Mount for exterior illumination (perimeters, pathways, loading docks, and other general security lighting requirements)

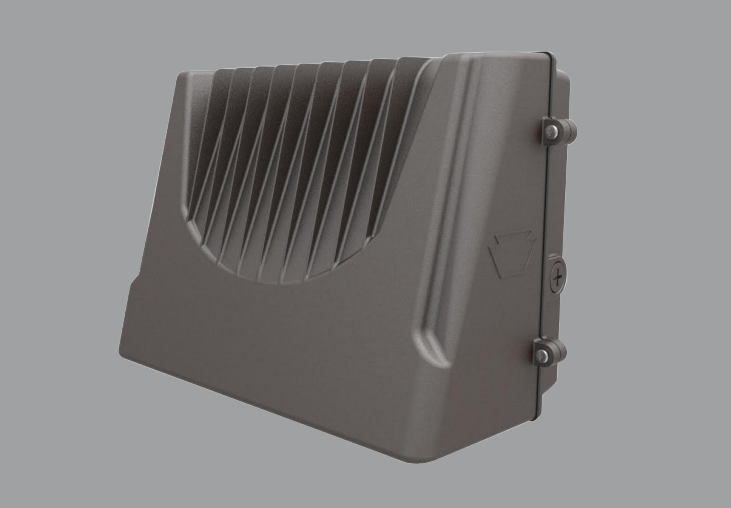

PRODUCT FEATURES

- Architectural full-cutoff design improves the appearance of building exteriors and optimizes functional light distribution
- Heavy-duty, die-cast aluminum housing features modern aesthetics while retaining (5) available 1/2" threaded conduit hubs: (1) on back and (1) on all four sides
- Powered by Keystone 0–10V dimming LED drivers
- Dark Sky friendly performance, eliminates undesirable sky glow and glare
- Features one translucent 3/4" threaded plug with anti-yellowing agent for use with photocell accessory KT-WPLED-PS-UV-KO
- Precision-crafted optical lens provides wide distribution pattern ideal for increased fixture spacing and uniformity
- Covers footprint of mid-size HID wallpacks
- Ambient operating temperature: –20°C/–4°F to 45°C/113°F
- UL listed for wet locations, IP65
- 0–10V dimming, 10% min
- Power Factor: >0.95
- THD: <20%
- LED chip lifetime: L70 >100,000 hrs @ 25°C/77°F ambient fixture temp
- Meets FCC Part 15, Part B, Class A standards for conducted and radiated emissions

ELECTRICAL SPECIFICATIONS

Catalog Number	Wattage	Lumens	Lumens Below 90°	Dimming	CCT	Efficacy	CRI	Housing Color	Input Voltage	Rated Life	Legacy Equivalent
KT-WPLED60-M2-840-VDIM	60W	7500 lm	7445 lm	0–10V	4000K	125 lm/W	>80	Bronze	120–277V	50,000 hrs	250W MH
KT-WPLED60-M2-850-VDIM		7800 lm	7745 lm		5000K	130 lm/W					

KT-WPLED60-M2-8XX-VDIM
ARCHITECTURAL 60W FULL-CUTOFF LED WALL PACK

PHOTOMETRIC SPECIFICATIONS

ISOCANDELA PLOT

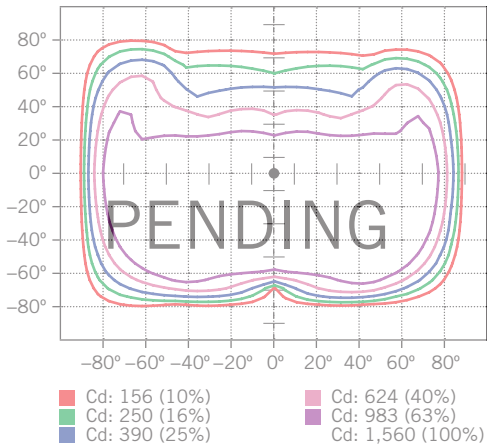

LUMINOUS INTENSITY DISTRIBUTION

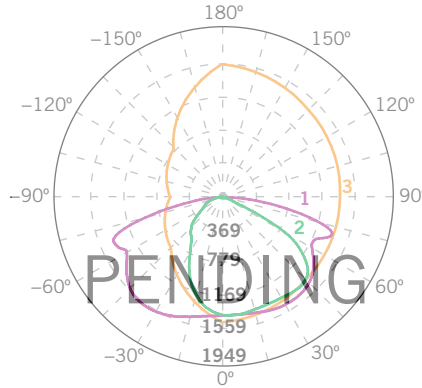

Average diffuse angle (50%): 125.1°

Unit: cd

FLUX DISTRIBUTION

Zone	Lumens	% Luminaire
Forward Light	3,171 lm	62.0%
0°-30°	596 lm	11.6%
30°-60°	1,594 lm	31.2%
60°-80°	912 lm	17.8%
80°-90°	70 lm	1.4%
Back Light	1,905 lm	37.2%
0°-30°	514 lm	10.1%
30°-60°	876 lm	17.1%
60°-80°	460 lm	9.0%
80°-90°	54 lm	1.1%
Up Light	39 lm	0.8%
90°-100°	3 lm	0.1%
100°-180°	36 lm	0.7%

BUG* Rating

Asymmetrical Luminaire Types	
Type I, II, III, IV	B2 U2 G1
Quadrilateral Symmetrical Luminaire Types	
Type V, Area Light	B2 U2 G1

* Backlight, Uplight, Glare

MOUNTING

Side view

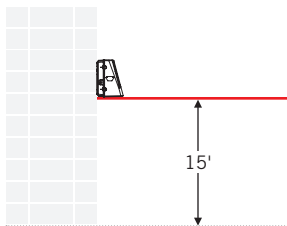

LIGHT DISTRIBUTION PATTERN

Isometric view from above; Luminaire mounted at 15'

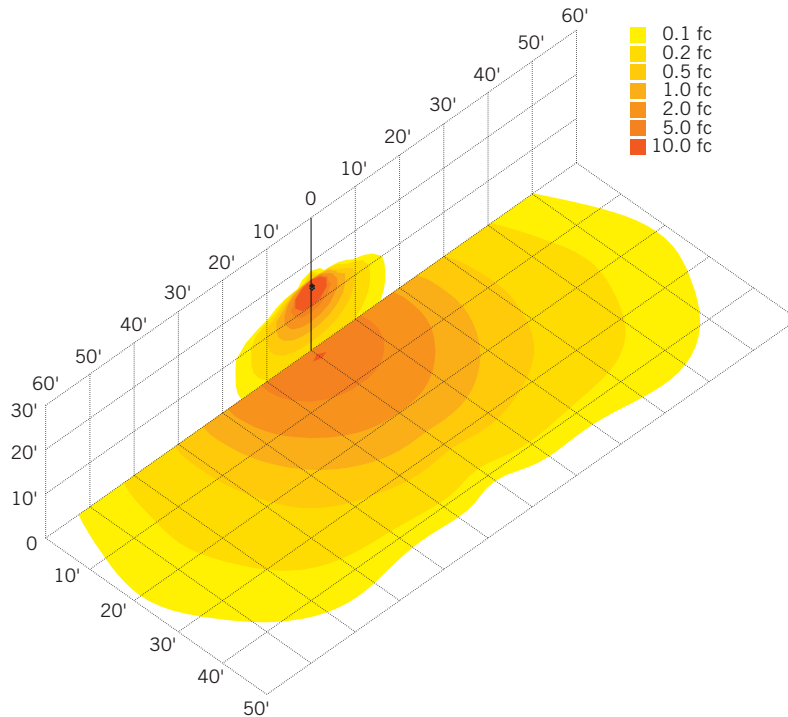



KT-WPLED60-M2-8XX-VDIM

ARCHITECTURAL 60W FULL-CUTOFF LED WALL PACK

PHYSICAL SPECIFICATIONS

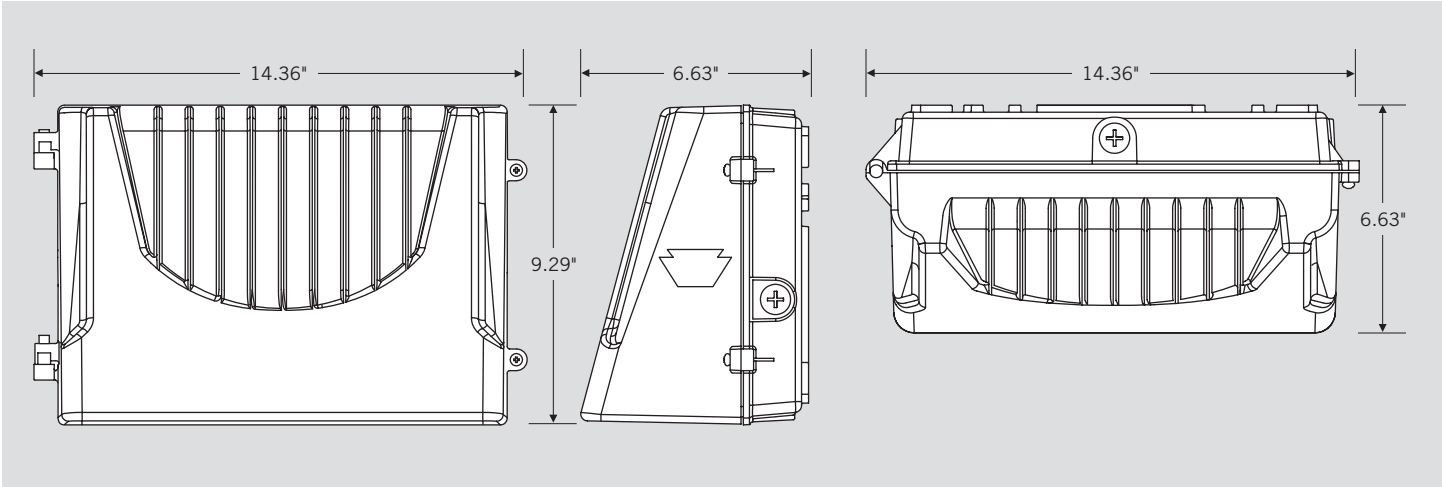

GENERAL SETUP INSTRUCTIONS

GENERAL WIRING DIAGRAM

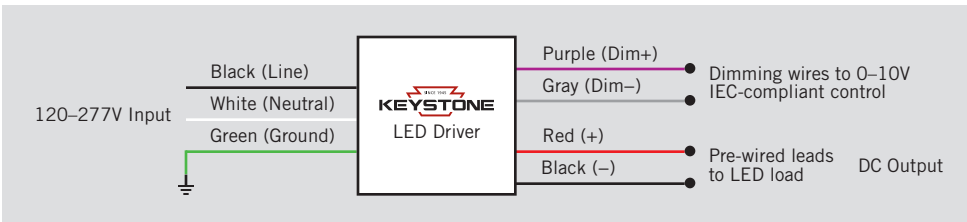

Caution: Before installing, make certain that AC power to the fixture is off.

Caution: The electrical rating of this product is 120–277V. Installer must confirm that there is 120–277V at the fixture before installation.

ACCESSORIES (SOLD SEPARATELY)

Catalog Number	Description
KTSP-10KV-C	Wallpack 10kV Surge Protector, Compact Design
KT-WPLED-PS-UV-KO	Keystone Wall Pack Button Photocell



KT-WPLED60-M2-8XX-VDIM

ARCHITECTURAL 60W FULL-CUTOFF LED WALL PACK

ORDERING INFORMATION

ORDER CODE	PACK QTY.	ITEM STATUS
KT-WPLED60-M2-840-VDIM	1	Quick Ship
KT-WPLED60-M2-850-VDIM	1	Quick Ship

CATALOG NUMBER BREAKDOWN

KT-WPLED60-M2-8XX-VDIM

- 1
- 2
- 3
- 4
- 5
- 6
- 7
- 8
- 9

- 1** Keystone Technologies
- 2** Fixture Type
- 3** LED Lamp
- 4** Max Wattage
- 5** Size
- 6** Style
- 7** CRI
- 8** Color
- 9** Dimming

2 Fixture Type

F	Flood
WP	Wallpack

5 Size

S	Small
M	Medium
L	Large

6 Style

1	Non-Cutoff
2	Full-Cutoff

7 CRI

8	>80
9	>90

8 Color

40	4000K
50	5000K

9 Dimming

VDIM	0-10V
------	-------