



KT-LED82P-EV-8xx-D

2-PIN LED LAMP

DESCRIPTION

8W 2-Pin LED Lamp | 2700K, 3000K, 3500K, 4000K, 5000K | ≥ 83 CRI



LAMP TYPE: Compact
BULB TYPE: 2-Pin LED
BASE TYPE: G24d
WATTAGE: 8W
COLOR TEMPERATURE: 2700K, 3000K, 3500K, 4000K, 5000K
COLOR RENDERING INDEX (CRI): ≥ 83
WARRANTY: 5 Years



PRODUCT FEATURES

- Replaces 26W/32W/42W G24d & G24q CFL Lamps
- 50,000+ Hour Lifetime
- Approximately 50% More Energy Efficient than Traditional CFL Lamps
- Environmentally Friendly: No Mercury Used
- Instant Startup
- Frosted Lens Eliminates Pixelation
- Integral Driver, Eliminates the Need for External Driver or Ballast
- UL Recognized and UL Classified
- Operating Temperature: -20°C/-4°F to 45°C/113°F
- Up to 5x Longer Life than Traditional CFL Lamps
- Extended Vertical Orientation

OPERATING SPECIFICATIONS

ELECTRICAL CHARACTERISTICS

Input Voltage	Lamp Wattage	Power Factor	System Wattage
120-277V	8W	>0.9	8W

PHOTOMETRIC CHARACTERISTICS

Color Temperature (CCT)	2700K	3000K	3500K	4000K	5000K
Luminous Flux	900 lm	900 lm	900 lm	950 lm	950 lm
Color Rendering Index (CRI)	≥ 83	≥ 83	≥ 83	≥ 83	≥ 83
Bare Lamp Efficacy	113 lm/W	113 lm/W	113 lm/W	119 lm/W	119 lm/W
Beam Angle	>120°	>120°	>120°	>120°	>120°

POLAR CANDELA DISTRIBUTION

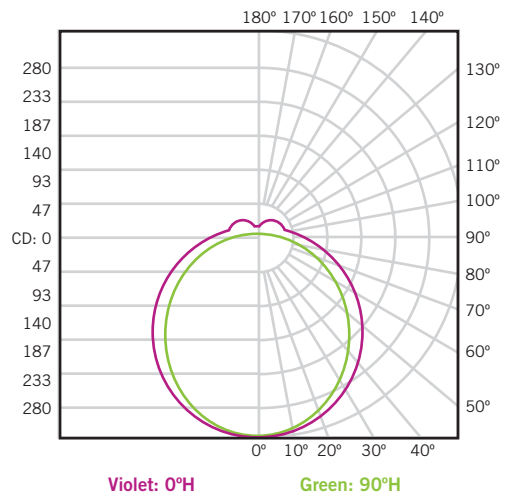

RATED LIFE

L70 (Hours)	50,000
-------------	--------



KT-LED82P-EV-8xx-D

2-PIN LED LAMP

WIRING

BYPASS MAGNETIC BALLAST WITH 1 LAMP

BEFORE

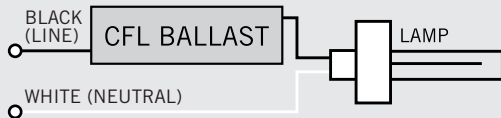

AFTER

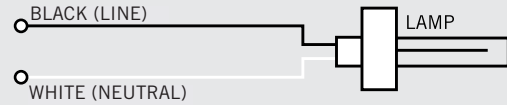

BYPASS ELECTRONIC BALLAST WITH 1 LAMP

BEFORE

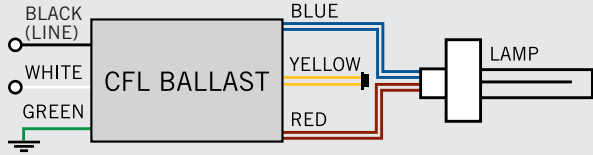

AFTER

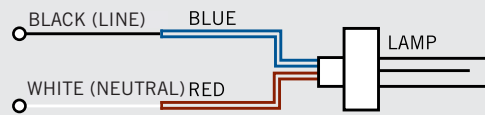

BYPASS MAGNETIC BALLAST WITH 2 LAMPS

BEFORE

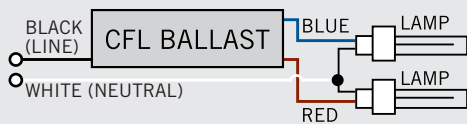

AFTER

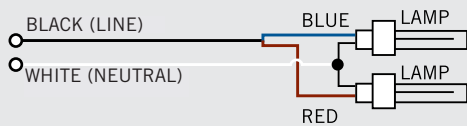

BYPASS ELECTRONIC BALLAST WITH 2 LAMPS

BEFORE

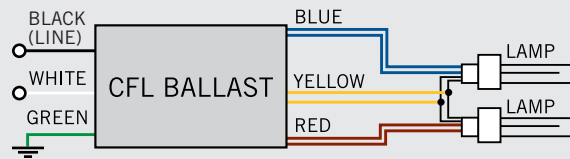

AFTER

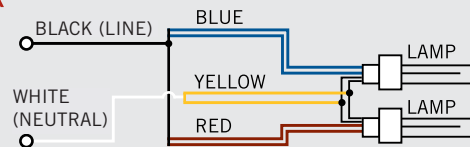

PHYSICAL CHARACTERISTICS

LAMP DIMENSIONS

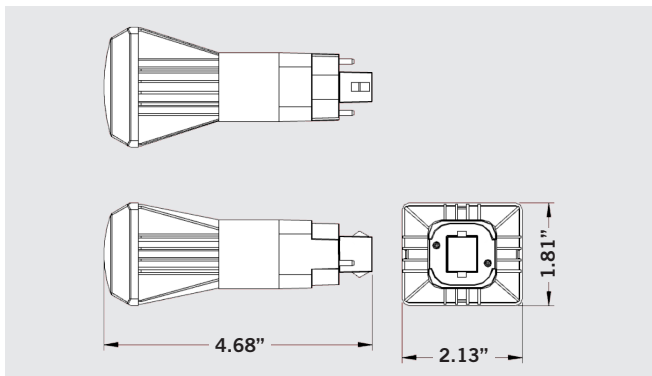



KT-LED82P-EV-8xx-D

2-PIN LED LAMP

ORDERING INFORMATION

ORDER CODE	PACKAGING STYLE	PACK QTY.	ITEM STATUS
KT-LED82P-EV-8xx-D-DP	Distributor Pack	50	Quick Ship

CATALOG NUMBER BREAKDOWN

KT-LED82P-EV-8xx-D

