



KT-LED17PLL-22GC-8XX-D /G2

PLL LED LAMP

DESCRIPTION

17W PLL LED | 3000-5000K | >80 CRI | High-Efficiency



LAMP TYPE: PLL
BASE TYPE: 2G11
WATTAGE: 17W
COLOR TEMPERATURE: 3000-5000K
COLOR RENDERING INDEX (CRI): >80
WARRANTY: 5 Years

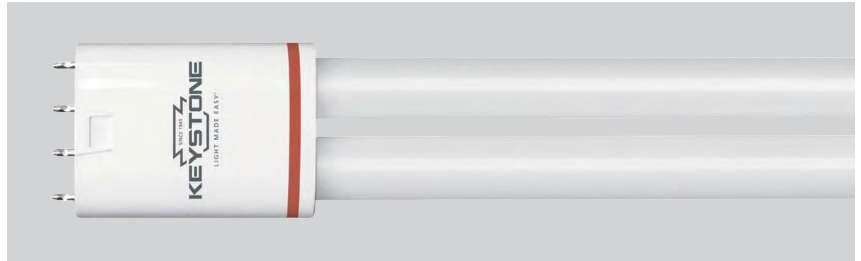

PRODUCT FEATURES

- Replacement for conventional fluorescent lamp
- UL Classified
- 50,000+ hour lifetime
- Approximately 50% more energy efficient than standard FT40/2G11 lamps
- Environmentally friendly: No mercury used
- Integral driver (isolated) eliminates the need for an external ballast or driver
- Instant startup
- Not dimmable
- Frosted lens eliminates pixelation
- Operating temperature: -20°C/-4°F to 45°C/113°F
- 100+ Lumens per Watt (bare lamp efficacy)
- Suitable for dry and damp locations
- NSF Listed: NSF/ANSI Standard 2 - Food Equipment
- Suitable for enclosed fixture. Minimum lamp compartment dimensions: 61.5cm x 60.5cm x 10.5cm

OPERATING SPECIFICATIONS

ELECTRICAL AND PERFORMANCE CHARACTERISTICS

Catalog Number	Input Voltage	CRI	Wattage	Nominal Lumens	Color Temp.	Beam Angle	Efficacy	Power Factor	Max. THD
KT-LED17PLL-22GC-830-D	120-277V	>80	17W	2050	3000K	160°	121 lm/W	>0.9	20%
KT-LED17PLL-22GC-835-D	120-277V	>80	17W	2100	3500K	160°	127 lm/W	>0.9	20%
KT-LED17PLL-22GC-840-D	120-277V	>80	17W	2200	4000K	160°	129 lm/W	>0.9	20%
KT-LED17PLL-22GC-850-D	120-277V	>80	17W	2200	5000K	160°	129 lm/W	>0.9	20%

PHOTOMETRIC SPECIFICATIONS

ISOCANDELA PLOT

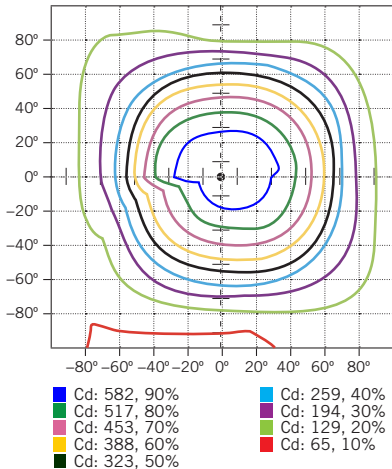

POLAR CANDELA DISTRIBUTION

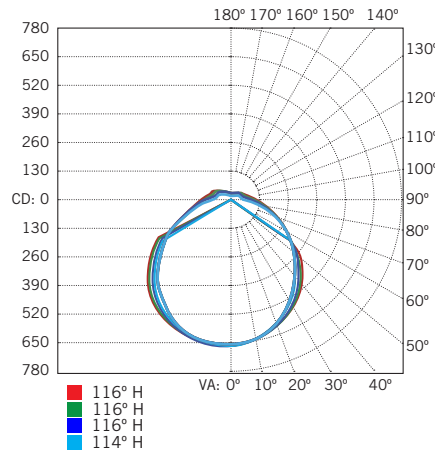

LUX DISTANCE CURVE

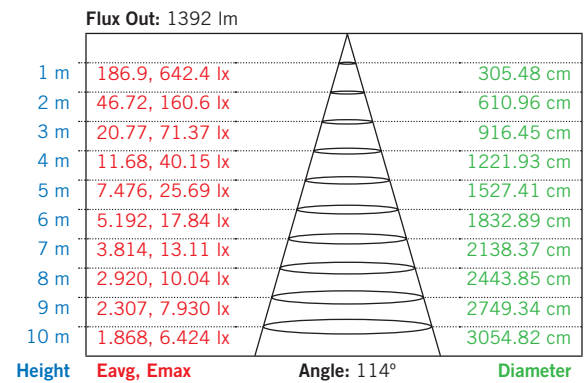

NOTE: Charts are represented by 5000K

KT-LED17PLL-22GC-8XX-D /G2
PLL LED LAMP

WIRING DIAGRAMS

1. Cut all existing connections to ballast as shown below and remove ballast.

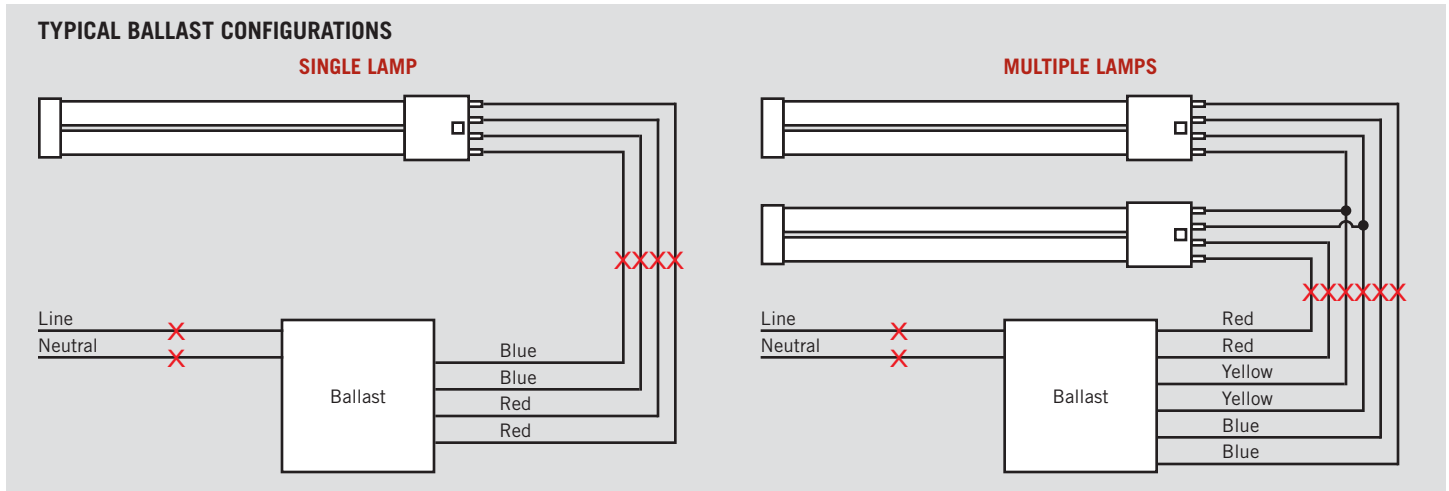

2. Re-wire fixture as shown below.

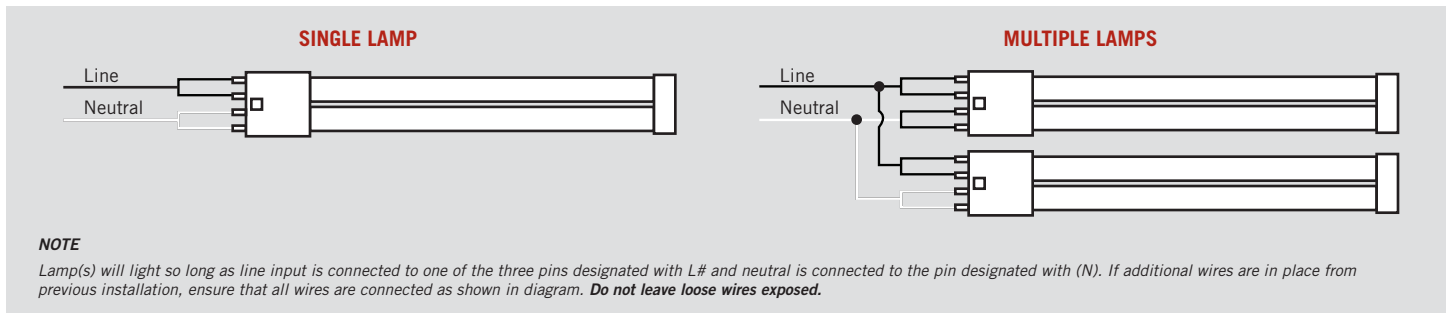

PHYSICAL CHARACTERISTICS

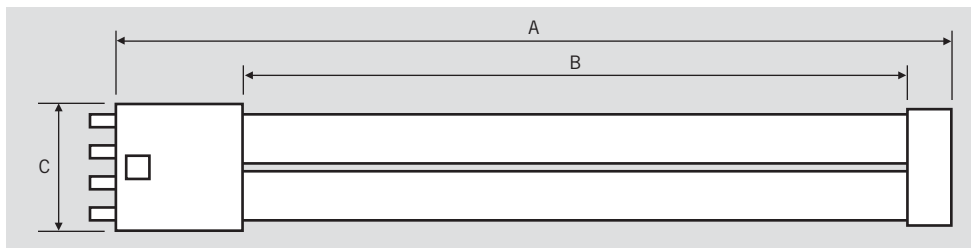

LAMP DIMENSIONS

A (Body Length)	21.8"
B (Illuminated Length)	18.9"
C (Width)	1.7"

BASE TYPE: 2G11



KT-LED17PLL-22GC-8XX-D /G2

PLL LED LAMP

ORDERING INFORMATION

ORDER CODE	PACK QTY.	EASY CODE	UPC
KT-LED17PLL-22GC-830-D /G2	24	YMX-12	843654131108
KT-LED17PLL-22GC-835-D /G2	24	TWJ-68	843654131115
KT-LED17PLL-22GC-840-D /G2	24	SFM-03	843654131122
KT-LED17PLL-22GC-850-D /G2	24	EGB-03	843654131139

CATALOG NUMBER BREAKDOWN

KT-LED17PLL-22GC-8XX-D /G2

1
2
3
4
5
6
7
8
9
10

- 1** Keystone Technologies
- 2** LED Lamp
- 3** Wattage
- 4** Lamp Type
- 5** Nominal Length (Inches)
- 6** Glass
- 7** 800 Series
- 8** Color Temperature
- 9** Direct-Drive Series
- 10** 2nd Generation